

Outdoor LED modules 5050

A rectangular solution for outdoor lighting. Compatible with standard 2x2 optics for example LEDiL's STRADA-2x2-5050.

Product description

- Long life-time
- Built-in, constant current LED module
- Re-workable push-in terminals enabling easy connection
- Compliance and approval: CE, ENEC
- Available CCT from 2700K to 6500K and CRI 70, 80, 90, 95



RecLED 122x50mm 2x4 5050 CRI 70 Optimum G2

Product name	Ordering code	Colour temperature [K]	Current nominal If nom [mA]	Luminous flux ¹ φ [lm]	Useful luminous flux ² [lm]	Voltage ¹ Vf [V]	Power ¹ P [W]	Efficacy ¹ [lm/W]	Current minimum If min ³ [mA]	Current maximum If max [mA]	Energy Efficiency Class
RecLED 122x50mm 1900lm 730 2x4 5050 Opt G2	1010 117 71046	3000	460	1836	1975	22	10	184	80	1600	C
RecLED 122x50mm 1900lm 740 2x4 5050 Opt G2	1010 117 71146	4000	460	1836	1975	22	10	193	80	1600	B

RecLED 173x50mm 2x6 5050 CRI 70 Optimum G2

Product name	Ordering code	Colour temperature [K]	Current nominal If nom [mA]	Luminous flux ¹ φ [lm]	Useful luminous flux ² [lm]	Voltage ¹ Vf [V]	Power ¹ P [W]	Efficacy ¹ [lm/W]	Current minimum If min ³ [mA]	Current maximum If max [mA]	Energy Efficiency Class
RecLED 173x50mm 2900lm 730 2x6 5050 Opt G2	1010 117 71246	3000	460	2754	2963	33	15	184	80	1600	C
RecLED 173x50mm 2900lm 740 2x6 5050 Opt G2	1010 117 71346	4000	460	2885	3104	33	15	193	80	1600	B

RecLED 224x50mm 2x8 5050 CRI 70 Optimum G2

Product name	Ordering code	Colour temperature [K]	Current nominal If nom [mA]	Luminous flux ¹ φ [lm]	Useful luminous flux ² [lm]	Voltage ¹ Vf [V]	Power ¹ P [W]	Efficacy ¹ [lm/W]	Current minimum If min ³ [mA]	Current maximum If max [mA]	Energy Efficiency Class
RecLED 224x50mm 3800lm 730 2x8 5050 Opt G2	1010 117 71446	3000	460	3671	3951	43	20	184	80	1600	C
RecLED 224x50mm 3800lm 740 2x8 5050 Opt G2	1010 117 71546	4000	460	3846	4139	43	20	193	80	1600	B

RecLED 274x50mm 2x10 5050 CRI 70 Optimum G2

Product name	Ordering code	Colour temperature [K]	Current nominal If nom [mA]	Luminous flux ¹ φ [lm]	Useful luminous flux ² [lm]	Voltage ¹ Vf [V]	Power ¹ P [W]	Efficacy ¹ [lm/W]	Current minimum If min ³ [mA]	Current maximum If max [mA]	Energy Efficiency Class
RecLED 274x50mm 4800lm 730 2x10 5050 Opt G2	1010 117 75946	3000	460	4589	4939	54	25	184	80	1600	C
RecLED 274x50mm 4800lm 740 2x10 5050 Opt G2	1010 117 76046	4000	460	4808	5174	54	25	193	80	1600	B

¹At nominal current and T_p

²At nominal current and 25°C

³It is recommended not to operate below minimum current in order to avoid un-even brightness

Tolerance range for optical and electrical ±10%

Temperature & humidity

Specification item	Unit	Value
T _p	[°C]	75
T _{p rated}	[°C]	75
T _c	[°C]	95
Relative humidity (non-condensing)	[%]	5 ... 85
Storage ambient temperature	[°C]	-25 ... +85
Storage relative humidity (non-condensing)	[%]	5 ... 85

T_p - Temperature related to the performance parameters of the LED modules

T_{p rated} - Maximum operating temperature to which the rated performance characteristics are declared

T_c - Highest permissible value for safe operation

Outdoor LED modules 5050

Technical data

Specification item	Unit	Value
Classification acc. to IEC 62031		built-in
Working voltage	[Vdc]	420
Beam angle	[deg]	120
Initial color consistency	[SDCM]	5
Photobiological safety		RG2 (RG1 at >0.5m distance)

Color coordinates

According to CIE 1931

Specification item	CIEx	CIEy
2700K	0.4578	0.4101
3000K	0.4338	0.4030
4000K	0.3818	0.3797
6500K	0.3123	0.3282

Certificates & standards

Specification item	Compliant
ENEC	Yes
CE	Yes
RoHS	Yes
REACH	Yes
Zhaga	Comply with Book 15
IP rating	No IP rating

Lumen maintenance

RecLED CRI 70

Forward current	Tp temp.	L70 [h]		L80 [h]		L90 [h]	
		B50	B10	B50	B10	B50	B10
If nom	75°C	>100 000	>100 000	>100 000	>100 000	>100 000	>100 000
	80°C	>100 000	>100 000	>100 000	>100 000	>100 000	>100 000
	85°C	>100 000	>100 000	>100 000	>100 000	>100 000	>100 000
	90°C	>100 000	>100 000	>100 000	>100 000	>100 000	>100 000
	95°C	>100 000	>100 000	>100 000	>100 000	99 000	85 000
If max	45°C	>100 000	>100 000	>100 000	>100 000	>100 000	>100 000
	55°C	>100 000	>100 000	>100 000	>100 000	>100 000	90 000
	65°C	>100 000	>100 000	>100 000	>100 000	65 000	57 000
	75°C	>100 000	>100 000	>100 000	>100 000	42 000	37 000
	85°C	>100 000	>100 000	>100 000	90 000	27 000	24 000

simulation based on LM80 LED data 10 000h

Outdoor LED modules 5050

Dimensions

RecLED 122x50mm 2x4

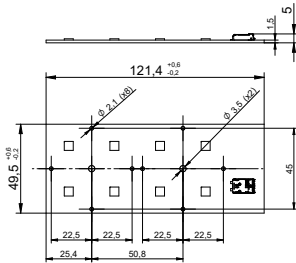

RecLED 173x50mm 2x6

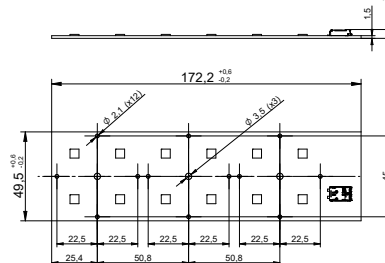

RecLED 224x50mm 2x8

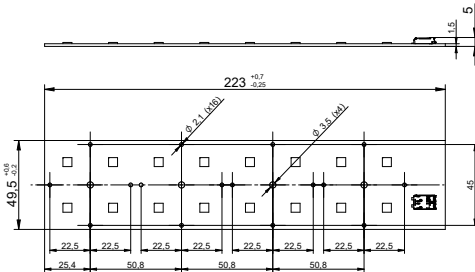

RecLED 274x50mm 2x10

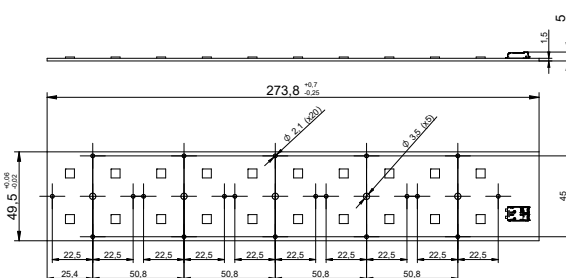

Mounting

LED Modules cannot be exposed to tensile or compressive stresses. For this purpose it is necessary that the modules are assembled to a flat surface by only rounded head screws. Additionally plastic flat washer should be used to ensure creepage distance between screw's head and surface of the pcb. Max. torque for fixing: 0,5Nm.

LED modules are sensitive to electrostatic discharge (ESD). Follow safety regulations according to IEC 61340-5-1.

Wiring

Wire cross section and strip length:

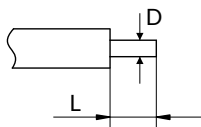

D - wire cross section (solid and flexible wires)	Min	Max
	0.2mm ²	0.75mm ²
	AWG 24	AWG 18

L - strip length	Min	Max
	8mm	9mm

Opening for the release of wires from the top with release pin Electroterminal art. 881 167 884:



Outdoor LED modules 5050

Connections

Max number of modules	Unit	Series	Parallel
RecLED 122x50mm 2x4 5050	[pcs]	16	-
RecLED 173x50mm 2x6 5050	[pcs]	10	-
RecLED 224x50mm 2x8 5050	[pcs]	8	-
RecLED 274x50mm 2x10 5050	[pcs]	6	-

Wiring for series connection system

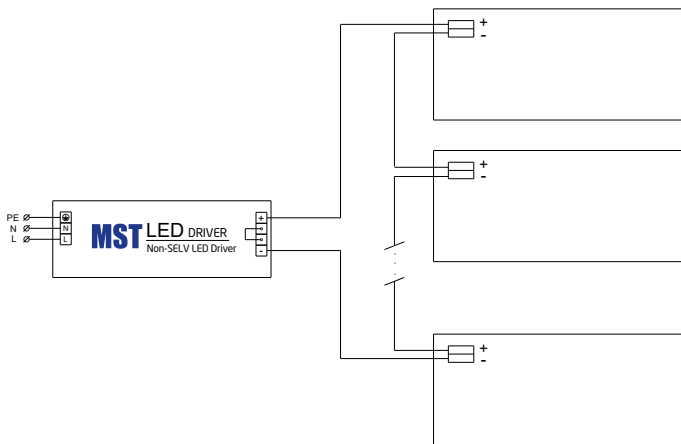

Energy Label / EPREL database

To obtain Energy Label for this product visit <https://eprel.ec.europa.eu/> and enter model identifier

Model identifier consists of 10 digits XXXX XXX XXX. It is printed directly on the LED module or on product label. This is the number you can see in EPREL database.

Ordering code consist of 12 digits XXXX XXX XXX46. Additional last two digits means packaging of the product.

Ordering codes

Product name	Ordering code	Pieces per box	Pieces per pallet	Box dimensions [mm]
RecLED 122x50mm 1900lm 730 2x4 5050 Opt G2	1010 117 71046	40	11520	238 x 140 x 61
RecLED 122x50mm 1900lm 740 2x4 5050 Opt G2	1010 117 71146	40	11520	238 x 140 x 61
RecLED 173x50mm 2900lm 730 2x6 5050 Opt G2	1010 117 71246	40	8000	233 x 191 x 61
RecLED 173x50mm 2900lm 740 2x6 5050 Opt G2	1010 117 71346	40	8000	233 x 191 x 61
RecLED 224x50mm 3800lm 730 2x8 5050 Opt G2	1010 117 71446	36	6840	248 x 175 x 66
RecLED 224x50mm 3800lm 740 2x8 5050 Opt G2	1010 117 71546	36	6840	248 x 175 x 66
RecLED 274x50mm 4800lm 730 2x10 5050 Opt G2	1010 117 75946	30	4800	298 x 178 x 58
RecLED 274x50mm 4800lm 740 2x10 5050 Opt G2	1010 117 76046	30	4800	298 x 178 x 58