

## Outdoor LED modules 5050 G2

A rectangular solution for outdoor lighting. Compatible with standard 2x2 optics for example LEDiL Strada 2x2-5050.

### Product description

- Long life-time
- Built-in, constant current LED module
- Re-workable push-in terminals enabling easy connection
- Compliance and approval: CE, ENEC
- Available CCT from 2200K to 6500K and CRI 80, 90
- Minimum driving current 80mA



### RecLED 2x4 5050 G2

	Ordering code	Colour temperature [K]	Current nominal If nom [mA]	Luminous flux* Φ [lm]	Voltage* Vf [V]	Power* P [W]	Efficacy* [lm/W]	Current maximum If max [mA]
RecLED 122x50mm 1900lm 730 2x4 5050 Opt G2	1010 117 71046	3000	460	1836	22	10	184	1600z
RecLED 122x50mm 1900lm 740 2x4 5050 Opt G2	1010 117 71146	4000	460	1923	22	10	193	1600

### RecLED 2x6 5050 G2

	Ordering code	Colour temperature [K]	Current nominal If nom [mA]	Luminous flux* Φ [lm]	Voltage* Vf [V]	Power* P [W]	Efficacy* [lm/W]	Current maximum If max [mA]
RecLED 173x50mm 2900lm 730 2x6 5050 Opt G2	1010 117 71246	3000	460	2754	33	15	184	1600
RecLED 173x50mm 2900lm 740 2x6 5050 Opt G2	1010 117 71346	4000	460	2885	33	15	193	1600

### RecLED 2x8 5050 G2

	Ordering code	Colour temperature [K]	Current nominal If nom [mA]	Luminous flux* Φ [lm]	Voltage* Vf [V]	Power* P [W]	Efficacy* [lm/W]	Current maximum If max [mA]
RecLED 224x50mm 3800lm 730 2x8 5050 Opt G2	1010 117 71446	3000	460	3671	43	20	184	1600
RecLED 224x50mm 3800lm 740 2x8 5050 Opt G2	1010 117 71546	4000	460	3846	43	20	193	1600

### RecLED 2x10 5050 G2

	Ordering code	Colour temperature [K]	Current nominal If nom [mA]	Luminous flux* Φ [lm]	Voltage* Vf [V]	Power* P [W]	Efficacy* [lm/W]	Current maximum If max [mA]
RecLED 274x50mm 4800lm 730 2x10 5050 Opt G2	1010 117 75946	3000	460	4589	54	25	184	1600
RecLED 274x50mm 4800lm 740 2x10 5050 Opt G2	1010 117 76046	4000	460	4808	54	25	193	1600

\*At nominal current and Tp  
Tolerance range for optical and electrical ±10%

### Temperature & humidity

Specification item	Unit	Value
Tp	[°C]	75
Tp rated	[°C]	75
Tc	[°C]	95
Relative humidity (non-condensing)	[%]	5 ... 85
Storage ambient temperature	[°C]	-25 ... +85
Storage relative humidity (non-condensing)	[%]	5 ... 85

Tp - Temperature related to the performance parameters of the LED modules  
Tp rated - Maximum operating temperature to which the rated performance characteristics are declared  
Tc - Highest permissible value for safe operation

## Outdoor LED modules 5050 G2

### Technical data

Specification item	Unit	Value
Classification acc. to IEC 62031	[V]	built-in
Energy Efficiency Class		A++
Working voltage	[Vdc]	420
Beam angle	[deg]	120
Initial color consistency	[SDCM]	5
Initial color coordinates		Acc. to CIE 1931
Photobiological safety		RG2 (RG1 @ >0,5m distance)

### Certificates & standards

Specification item	Compliant
ENEC	Yes
CE	Yes
RoHS	Yes
REACH	Yes
Zhaga	Comply with book 15
IP rating	No IP rating

### Lumen maintenance

#### RecLED CRI 70

Forward current	Tp temperature	L70 [h]		L80 [h]		L90 [h]	
		B50	B10	B50	B10	B50	B10
If nom	75°C	>100 000	>100 000	>100 000	>100 000	>100 000	>100 000
	80°C	>100 000	>100 000	>100 000	>100 000	>100 000	>100 000
	85°C	>100 000	>100 000	>100 000	>100 000	>100 000	>100 000
	90°C	>100 000	>100 000	>100 000	>100 000	>100 000	>100 000
	95°C	>100 000	>100 000	>100 000	>100 000	99 000	85 000
If max	75°C	>100 000	>100 000	>100 000	>100 000	>100 000	>100 000
	80°C	>100 000	>100 000	>100 000	>100 000	>100 000	90 000
	85°C	>100 000	>100 000	>100 000	>100 000	65 000	57 000
	90°C	>100 000	>100 000	>100 000	>100 000	42 000	37 000
	95°C	>100 000	>100 000	90 000	78 000	27 000	24 000

simulation based on LM80 LED data (10 000h)

## Outdoor LED modules 5050 G2

### Dimensions

RecLED 122x50mm 2x4

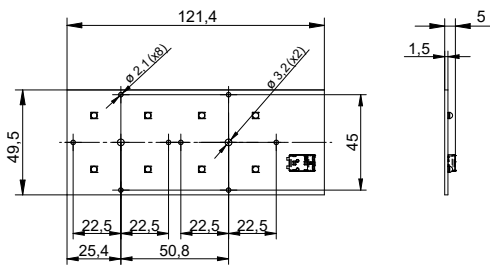

RecLED 173x50mm 2x6

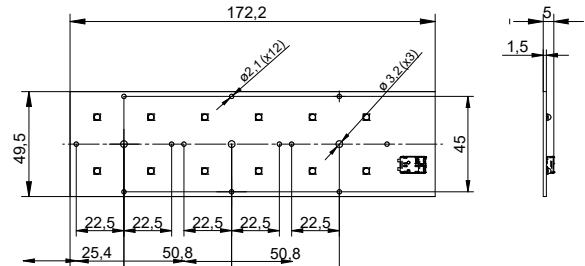

RecLED 224x50mm 2x8

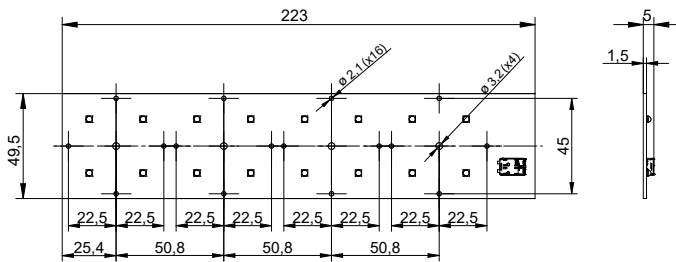

RecLED 274x50mm 2x10

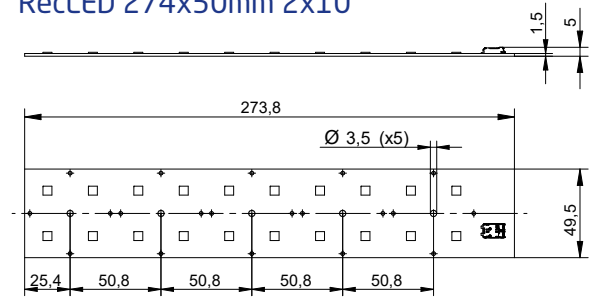

### Wiring

Wire cross section and strip length:

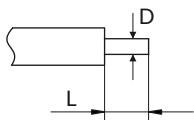

D - wire cross section <i>solid and flexible wires</i>	Min	Max
	0.2mm <sup>2</sup> AWG 18	0.75mm <sup>2</sup> AWG 24

L - strip length	Min	Max
	8mm	9mm

Opening for the release of wires from the top with release pin Electroterminal art. 881 167 884:

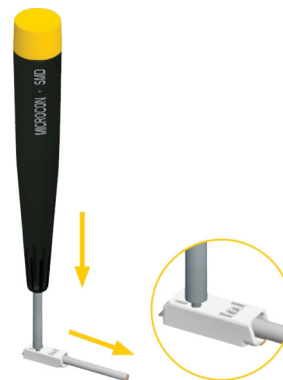

## Outdoor LED modules 5050 G2

### Connections

Max number of modules	Unit	Series	Parallel
RecLED 122x50mm	[pcs]	19	-
RecLED 173x50mm	[pcs]	12	-
RecLED 224x50mm	[pcs]	9	-
RecLED 274x50mm	[pcs]	7	-

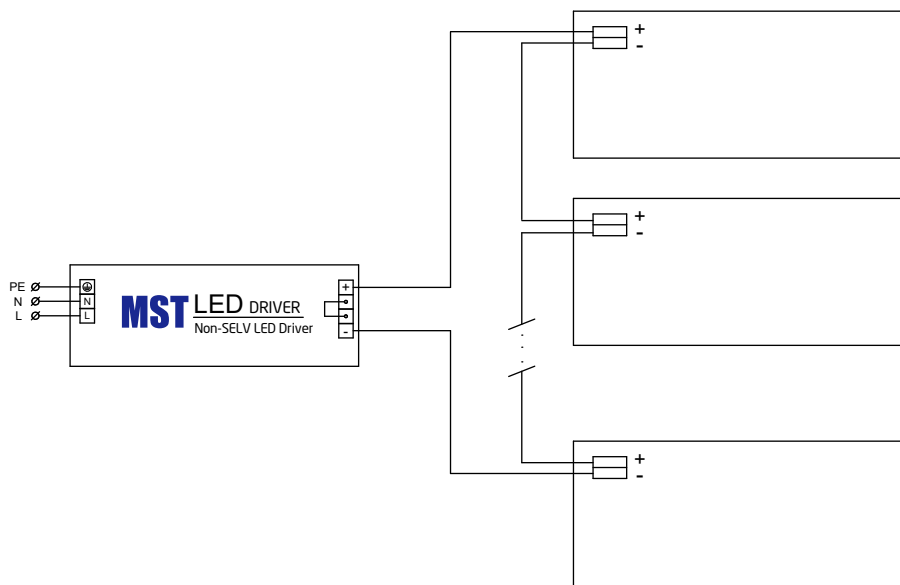

### Mounting

LED Modules cannot be exposed to tensile or compressive stresses. For this purpose it is necessary that the modules are assembled to a flat surface by only rounded head screws. Additionally plastic flat washer should be used to ensure creepeage distance between screw's head and surface of the pcb. Max. torque for fixing: 0,5Nm.

LED modules are sensitive to electrostatic discharge (ESD). Follow safety regulations according to IEC 61340-5-1.

### Ordering codes

Specification item	Ordering code	Pieces per box	Pieces per pallet	Box dimensions [mm]	Product weight [g]	Gross weight [kg]
RecLED 122x50mm 1900lm 730 2x4 5050 Opt G2	1010 117 71046	40	11520	238 x 140 x 61	24	330
RecLED 122x50mm 1900lm 740 2x4 5050 Opt G2	1010 117 71146	40	11520	238 x 140 x 61	24	330
RecLED 173x50mm 2900lm 730 2x6 5050 Opt G2	1010 117 71246	40	8000	233 x 191 x 61	37	350
RecLED 173x50mm 2900lm 740 2x6 5050 Opt G2	1010 117 71346	40	8000	233 x 191 x 61	37	350
RecLED 224x50mm 3800lm 730 2x8 5050 Opt G2	1010 117 71446	36	6840	248 x 175 x 66	47	370
RecLED 224x50mm 3800lm 740 2x8 5050 Opt G2	1010 117 71546	36	6840	248 x 175 x 66	47	370
RecLED 274x50mm 4800lm 730 2x10 5050 Opt G2	1010 117 75946	30	4800	298 x 178 x 58	57	310
RecLED 274x50mm 4800lm 740 2x10 5050 Opt G2	1010 117 76046	30	4800	298 x 178 x 58	57	310