

Outdoor LED modules

A rectangular solution for outdoor lighting. Compatible with standard 2x2 optics for example LEDiL's STRADA-2x2.

Product description

- Long life-time
- Built-in, constant current LED module
- Re-workable push-in terminals enabling easy connection
- Compliance and approval: CE, ENEC, ENEC+
- Available CCT from 2700K to 6500K and CRI 70, 80, 90, 95



RecLED 173x151mm 6x6 CRI 70 Optimum G2

Product name	Ordering code	Colour temperature [K]	Current nominal If nom [mA]	Luminous flux ¹ φ [lm]	Useful luminous flux ² [lm]	Voltage ¹ Vf [V]	Power ¹ P [W]	Efficacy ¹ [lm/W]	Current minimum If min ³ [mA]	Current maximum If max [mA]	Energy Efficiency Class
RecLED 173x151mm 8700lm 730 6x6 Opt G2	1010 117 91746	3000	500	8574	9238	100	50	172	100	1500	C
RecLED 173x151mm 8700lm 740 6x6 Opt G2	1010 117 91846	4000	500	9086	9789	100	50	183	100	1500	C

RecLED 224x202mm 8x8 CRI 70 Optimum G2

Product name	Ordering code	Colour temperature [K]	Current nominal If nom [mA]	Luminous flux ¹ φ [lm]	Useful luminous flux ² [lm]	Voltage ¹ Vf [V]	Power ¹ P [W]	Efficacy ¹ [lm/W]	Current minimum If min ³ [mA]	Current maximum If max [mA]	Energy Efficiency Class
RecLED 224x202mm 15200lm 730 8x8 Opt G2	1010 117 92046	3000	500	15243	16423	177	88	172	100	1500	C
RecLED 224x202mm 15200lm 740 8x8 Opt G2	1010 117 92146	4000	500	16153	17403	177	88	183	100	1500	C

¹At nominal current and T_p

²At nominal current and 25°C

³It is recommended not to operate below minimum current in order to avoid un-even brightness

Tolerance range for optical and electrical ±10%

Temperature & humidity

Specification item	Unit	Value
T _p	[°C]	75
T _p rated	[°C]	75
T _c	[°C]	95
Relative humidity (non-condensing)	[%]	5 ... 85
Storage ambient temperature	[°C]	-25 ... +85
Storage relative humidity (non-condensing)	[%]	5 ... 85

T_p - Temperature related to the performance parameters of the LED modules

T_p rated - Maximum operating temperature to which the rated performance characteristics are declared

T_c - Highest permissible value for safe operation

Technical data

Specification item	Unit	Value
Classification acc. to IEC 62031		built-in
Working voltage	[Vdc]	420
Beam angle	[deg]	120
Initial color consistency	[SDCM]	5
Photobiological safety		RG2 (RG1 at >0.5m distance)

Outdoor LED modules

Color coordinates

According to CIE 1931

Specification item	CIE _x	CIE _y
2700K	0.4578	0.4101
3000K	0.4338	0.4030
4000K	0.3818	0.3797
6500K	0.3123	0.3282

Certificates & standards

Specification item	Compliant
ENEC	Yes
ENEC+	Yes
CE	Yes
RoHS	Yes
REACH	Yes
Zhaga	Comply with Book 15
IP rating	No IP rating

Lumen maintenance

RecLED CRI 70

Forward current	T _p temp.	L70 [h]		L80 [h]		L90 [h]	
		B50	B10	B50	B10	B50	B10
If nom	75°C	>100 000	>100 000	>100 000	>100 000	>100 000	>100 000
	80°C	>100 000	>100 000	>100 000	>100 000	>100 000	>100 000
	85°C	>100 000	>100 000	>100 000	>100 000	>100 000	>100 000
	90°C	>100 000	>100 000	>100 000	>100 000	>100 000	>100 000
	95°C	>100 000	>100 000	>100 000	>100 000	>100 000	>100 000
If max	45°C	>100 000	>100 000	>100 000	>100 000	>100 000	>100 000
	55°C	>100 000	>100 000	>100 000	>100 000	>100 000	>100 000
	65°C	>100 000	>100 000	>100 000	>100 000	82 000	77 000
	75°C	>100 000	>100 000	>100 000	>100 000	58 000	54 000
	85°C	>100 000	>100 000	>100 000	>100 000	41 000	38 000

simulation based on LM80 LED data 10 000h

Dimensions

RecLED 173x151mm

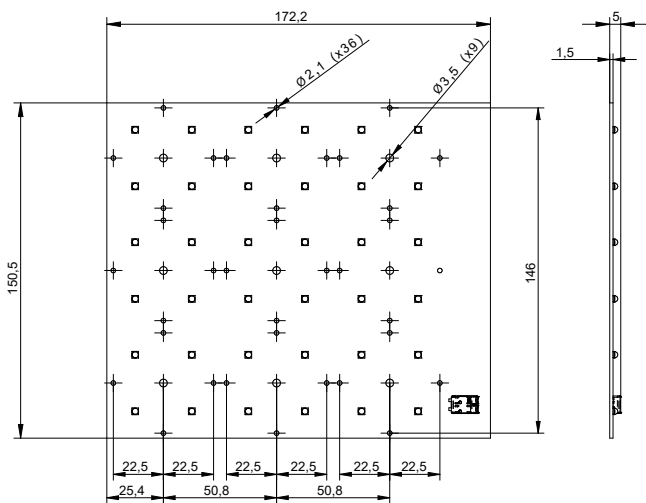

RecLED 224x202mm

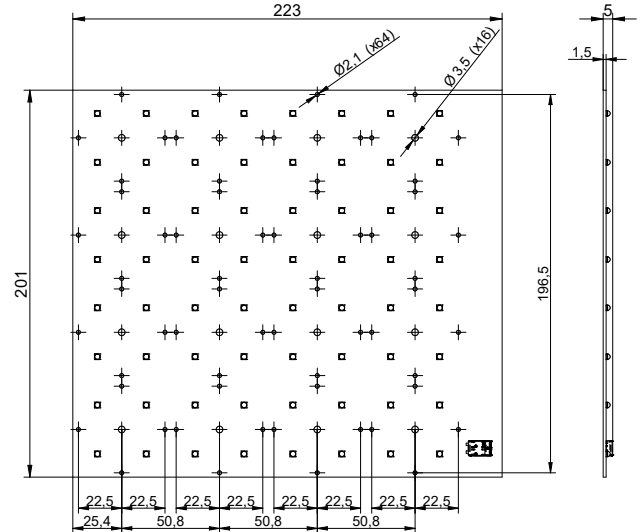

Outdoor LED modules

Mounting

LED Modules cannot be exposed to tensile or compressive stresses. For this purpose it is necessary that the modules are assembled to a flat surface by only rounded head screws. Additionally plastic flat washer should be used to ensure creepage distance between screw's head and surface of the pcb. Max. torque for fixing: 0,5Nm.

LED modules are sensitive to electrostatic discharge (ESD). Follow safety regulations according to IEC 61340-5-1.

Wiring

Wire cross section and strip length:

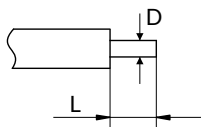

D - wire cross section (solid and flexible wires)	Min	Max
	0.2mm ²	0.75mm ²
	AWG 24	AWG 18

L - strip length	Min	Max
	8mm	9mm

Opening for the release of wires from the top with release pin Electroterminal art. 881 167 884:



Connections

Max number of modules	Unit	Series	Parallel
RecLED 173x151mm 6x6	[pcs]	3	-
RecLED 224x202mm 8x8	[pcs]	2	-

Wiring for series connection system

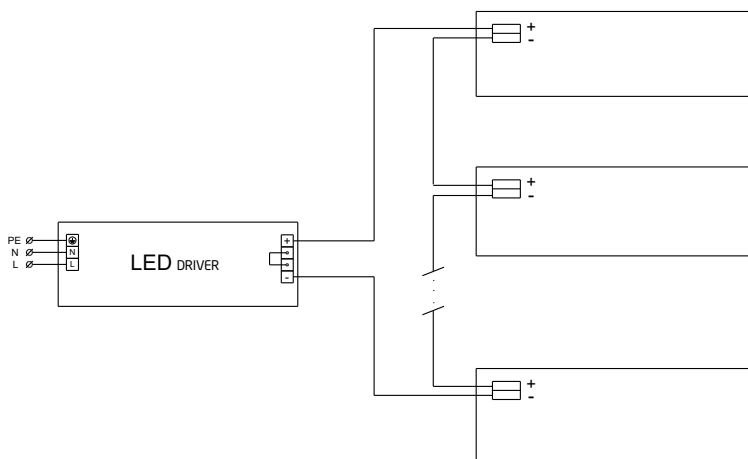

Energy Label / EPREL database

To obtain Energy Label for this product visit <https://eprel.ec.europa.eu/> and enter model identifier

Model identifier consists of 10 digits XXXX XXX XXX. It is printed directly on the LED module or on product label. This is the number you can see in EPREL database.

Ordering code consist of 12 digits XXXX XXX XXX46. Additional last two digits means packaging of the product.

Outdoor LED modules

Ordering codes

Product name	Ordering code	Pieces per box	Pieces per pallet	Box dimensions [mm]
RecLED 173x151mm 8700lm 730 6x6 Opt G2	1010 117 91746	20	2400	360 x 200 x 58
RecLED 173x151mm 8700lm 740 6x6 Opt G2	1010 117 91846	20	2400	360 x 200 x 58
RecLED 224x202mm 15200lm 730 8x8 Opt G2	1010 117 92046	20	1400	438 x 236 x 58
RecLED 224x202mm 15200lm 740 8x8 Opt G2	1010 117 92146	20	1400	438 x 236 x 58